



Installation Instructions



6" RTS Performance Suspension System

2001-2010 GM 2WD & 4WD 2500HD

Fabtech Motorsports 4331 EUCALYPTUS AVE. Chino, CA. 91710

Tech Line 909-597-7800

Fax 909-597-7185 Web www.fabtechmotorsports.com

6" RTS 2001-2010 GM 2WD & 4WD 2500HD

PARTS LIST

FTS21089		COMPONENT BOX 1
1	FT20061	DIFF.DROP BRKT PASS CLEAR ZINC
1	FT20062	DIFF.DROP BRKT DRVR CLEAR ZINC
1	FT20069BK	SKID PLATE BLACK
1	FT20071	SWAY BAR LINK
1	FT20074	CARRIER BEARING DROP BRKT
1	FT20075	WELD IN PLATE RAW
2	FT20247	CV SPACER-USE W/ FTS20246
1	FT20464	HARDWARE SUBASSEMBLY
1	FT20465	HARDWARE KIT
2	FT21089i	INSTRUCTIONS
1	FT90085	CHEVY DIF BUSHING KIT
1	FTAS12	STICKER
1	FTAS16	DECAL
1	FTREGCARD	REG CARD
2	FT20459	SLEEVE
2	FT20457	SHOCK SPACER
1	FTS20246D	HD SPINDLE DRIVER
1	FTS20246P	HD SPINDLE PASSENGER
1	FT20455BK	TORSION BAR RELOCATOR DRIV
1	FT20456BK	TORSION BAR RELOCATOR PASS

FTS21090		COMPONENT BOX 2
2	FT13	POP RIVET ALUMINUM
1	FT20057BK	FRONT CROSSMEMBER VULCAN BLACK
1	FT20458BK	REAR CROSSMEMBER BLACK
2	FT20284BK	CROSSMEMBER SUPPORT TUBE
1	FT58H	NUT 5/8" AND WASHER KIT
1	FT70014	E BRAKE BRACKET CLEAR ZINC
4	FT726U	UBOLT SQ 5/8-18X14.50X2.63
1	FT90023	LOGO PLATE .020 ALUM 5 1/2 X 1
2	FTBK41	BLOCK 4.0 IN

TOOL LIST: (NOT INCLUDED)

- JACK STANDS
- ASSORTED METRIC AND S.A.E SOCKETS, WRENCHES
- LARGE C CLAMP OR C CLAMP VISE GRIPS
- DIE GRINDER W/ CUTOFF WHEEL OR SAWZALL
- TORSION BAR REMOVAL TOOL
- TORQUE WRENCH
- MIG WELDER

FT20465 HARDWARE LIST:

Qty	Part Number	Description
1	10000005212	10mm Split Lock Washer
16	10000005412	10mm Flat Washer
12	10150401012	10mm-1.5 x 40mm Bolt
5	10150601012	10mm-1.5 x 60mm Bolt
2	25000005081	1/4" SAE Washer
2	25000005252	1/4" Split Lock Washer
2	25200751081	1/4"-20 x 3/4" Bolt
4	31000005081	5/16" SAE Flat Washer
2	31180003052	5/16"-18 Nylock Nut
1	31181251081	5/16"-18 x 1" Hex Head
1	31181251081	5/16"-18 x 1-1/4" Hex Head
4	37000005081	3/8" SAE Washer
2	37160003052	3/8"-16 Nylon Lock Nut
2	37162001081	3/8"-16 x 2" Bolt
2	50000005081	1/2" SAE Flat Washer
1	50130004152	1/2"-13 Steel Lock Nut
1	50131251081	1/2"-13 x 1-1/4" Bolt
8	56000005081	9/16" SAE Washer
5	56120004152	9/16"-12 Steel Lock Nut
2	56121751081	9/16"-12 x 1-3/4" Bolt
2	56124501081	9/16"-12 x 4-1/2" Bolt
1	56125001081	9/16-12 x 5" Bolt
8	62000005081	5/8" SAE Flat Washer
4	62110004152	5/8"-11 Steel Lock Nut
2	62115001081	5/8"-11 x 5" Bolt
2	62116001081	5/8"-11 x 6" Bolt
4	75000005081	3/4" SAE Washer
2	75100004152	3/4"-10 Steel Lock Nut
2	75105251081	3/4"-10 x 4-1/2" Bolt
2	FTLOCK	Thread Locking Compound
8	12008007100	Zip Tie 8"



**6" 2001-2010 GM 2WD & 4WD 2500HD RTS
FTS21089 / FTS21090**

INSTALLATION OF THIS SUSPENSION SYSTEM WILL NOT ALLOW THE USE OF THE FACTORY WHEELS OR SPARE TIRE ON THE FRONT SUSPENSION

WITH THE INSTALLATION OF THIS KIT YOU MUST RUN A 16X8 OR 17X8 RIM WITH A 4 5/8" BACK SPACING.

NOTE- THIS SUSPENSION SYSTEM REQUIRES WELDING FOR INSTALLATION. ALL WELDING MUST BE PERFORMED BY A CERTIFIED WELDER. ONLY WELD THE SINGLE COMPONENT CALLED OUT IN THESE INSTRUCTIONS. DO NOT WELD ANY OTHER COMPONENTS IN THIS SYSTEM.

VEHICLES THAT WILL RECEIVE OVERSIZED TIRES SHOULD CHECK BALL JOINTS, TIE RODS ENDS AND IDLER ARM EVERY 2500-5000 MILES FOR WEAR AND REPLACE AS NEEDED

THE INSTALLATION OF THIS SUSPENSION SYSTEM SHOULD BE PERFORMED BY TWO PROFESSIONAL MECHANICS.

DO NOT ALTER THE FINISH OF THESE COMPONENTS, EXAMPLE- CHROMING, ZINC PLATING OR PAINTING. CHANGING THE FINISH CAN CAUSE STRUCTURAL FATIGUE OF COMPONENTS.

KIT DOES NOT FIT STANDARD CAB MODEL TRUCKS

EXHAUST MODIFICATION IS REQUIRED TO INSTALL THIS SYSTEM AND CAN BE PERFORMED BY A MUFFLER SHOP

SUSPENSION SYSTEM MUST BE INSTALLED WITH FABTECH SHOCK ASBORBERS

VEHICLES WITH ONE PIECE REAR DRIVESHAFTS MAY EXPERIENCE DRIVELINE VIBRATION

CHECK ALL PARTS INCLUDED IN THIS KIT TO THE PARTS LIST ABOVE BEFORE BEGINNING INSTALLATION OF THE KIT. IF ANY PIECES ARE MISSING, CONTACT FABTECH AT 909-597-7800

READ ALL INSTRUCTIONS THOROUGHLY FROM START TO FINISH BEFORE BEGINNING INSTALLATION! IF THESE INSTRUCTIONS ARE NOT PROPERLY FOLLOWED, SEVERE FRAME, DRIVELINE AND / OR SUSPENSION DAMAGE MAY RESULT.

NOTE- PRIOR TO THE INSTALLATION OF THIS SUSPENSION SYSTEM A FRONT END ALIGNMENT MUST BE PERFORMED AND RECORDED. DO NOT INSTALL THIS SYSTEM IF THE VEHICLE ALIGNMENT IS NOT WITHIN FACTORY SPECIFICATIONS. CHECK FOR FRAME AND SUSPENSION DAMAGE PRIOR TO INSTALLTION.

THIS SYSTEM IS DESIGNED TO FIT BOTH TWO (2wd) AND FOUR (4wd) WHEEL DRIVE TRUCKS. ON TWO WHEEL DRIVE MODELS, DISREGARD ANY AND ALL STEPS INVOLVING THE FRONT DIFFERENTIAL AND C.V. SHAFT REMOVAL AND INSTALLATION

SUSPENSION SYSTEM WILL NOT WORK ON VEHICLES EQUIPPED WITH FACTORY AUTO RIDE SUSPENSION

VERIFY DIFFERENTIAL FLUID IS AT MANUFACTURES RECOMMENDED LEVEL PRIOR TO KIT INSTALLATION. INSTALLATION OF THE KIT WILL RE-POSITION THE DIFFERENTIAL AND THE FILL PLUG HOLE MAY BE IN A DIFFERENT POSITION. (FOR EXAMPLE, IF THE MANUFACTURE RECOMMENDS 3 QUARTS OF FLUID, MAKE SURE THE DIFF HAS 3 QUARTS OF FLUID). CHECK YOUR SPECIFIC MANUAL FOR CORRECT AMOUNT OF FLUID.

FRONT SUSPENSION INSTRUCTIONS:

1. Disconnect the negative terminal on the battery. With the vehicle on level ground, set the emergency brake and block the rear tires. Jack up the front end of the truck and support the frame rails with jack stands. **NEVER WORK UNDER AN UNSUPPORTED VEHICLE!** Remove the front tires.
2. Locate the torsion bar adjusting cams and threaded bolts. Measure exposed threads of torsion bar adjusting bolts and record for reinstallation. Mark torsion bars indicating driver and passenger. Using a torsion bar removal tool unload the torsion bars and remove bars. Retain the hardware for reinstallation. NOTE- Do not attempt to unload or remove torsion bars without the proper torsion bar tool. Torsion Bars are under extreme spring load.
3. Remove the sway bar link ends from the sway bar and lower control arm. Discard links and bushings.
4. Remove the stock shocks and discard.
5. Remove the stock lower rubber bump stops from the frame and retain.
6. Remove front factory differential skid plate and splash shield and discard. Retain hardware for front crossmember installation.
7. Disconnect the tie rod ends from the steering knuckle by striking the knuckle to dislodge the tie rod end. Use care not to damage the tie rod end when removing. SEE PHOTO BELOW



8. Remove the brake hose bracket from the top of the steering knuckle. Unplug the ABS brake connection from the frame and control arm. Remove the caliper from the rotor and place above the upper control arm during this portion of the installation.
9. Remove brake rotor from the steering knuckle. Remove axle nut, washer and the 4 hub bolts on backside of knuckle. Remove bearing hub assembly including O ring from knuckle. Retain parts and hardware for reinstallation.

10. Remove the upper and lower ball joint nuts. Disconnect the upper and lower ball joints from the steering knuckle by striking the knuckle with a large hammer next to each ball joint on the knuckle to dislodge the ball joints. Use care not to hit the ball joints when removing. Retain nuts and discard knuckle. SEE PHOTO BELOW



11. Disconnect CV axles from differential housing and remove axle assembly.
12. Remove the lower control arms from the frame and retain the arms and hardware for reinstallation.
13. Disconnect front drive shaft from differential housing and retain bolts and u joint clamps for reinstallation.
14. Disconnect the differential housing electrical connection and vacuum line from differential housing.
15. Remove the stock differential rear crossmember and discard. Remove the differential housing assembly from vehicle. To ease removal, turn the steering wheel to the left for centerlink clearance. Note- Some diesel models may require step 16 first in order to remove housing. Retain hardware for reinstallation.
16. Locate the driver side lower control arm pocket closest to the rear of the vehicle, measure 1-3/4" from the backside of the pocket and mark a vertical cut line around entire pocket. Using a Sawzall or die grinder cut the backside of the pocket and rear differential crossmember off the frame. SEE PHOTO BELOW.

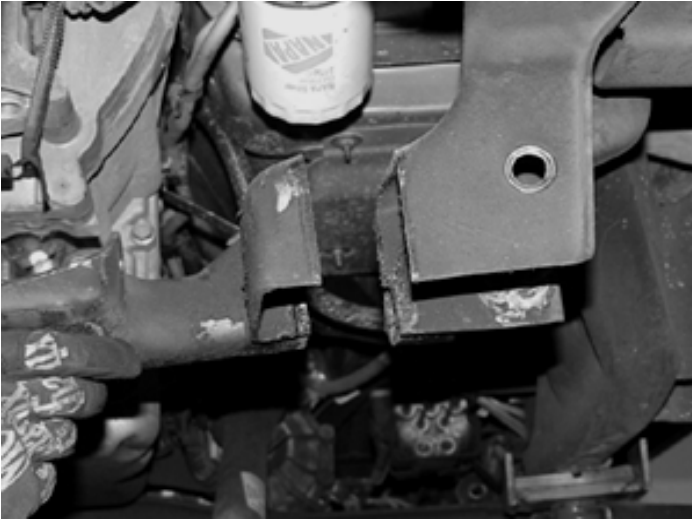

VIEW FROM FRONT OF TRUCK ON DRIVERS SIDE.

17. With the back of the pocket now removed, place the FT20075 plate up to the frame and weld in place. Let the plate cool and paint with a corrosive resistant paint or undercoating. SEE PHOTO BELOW



18. Locate the mounting bushing eye on the upper front side of the differential housing and mark the housing with a cut line flush to the housing. Using a sawzall cut the entire ear off the housing. Take care not to cut into the flat portion of the housing. SEE PHOTO BELOW.

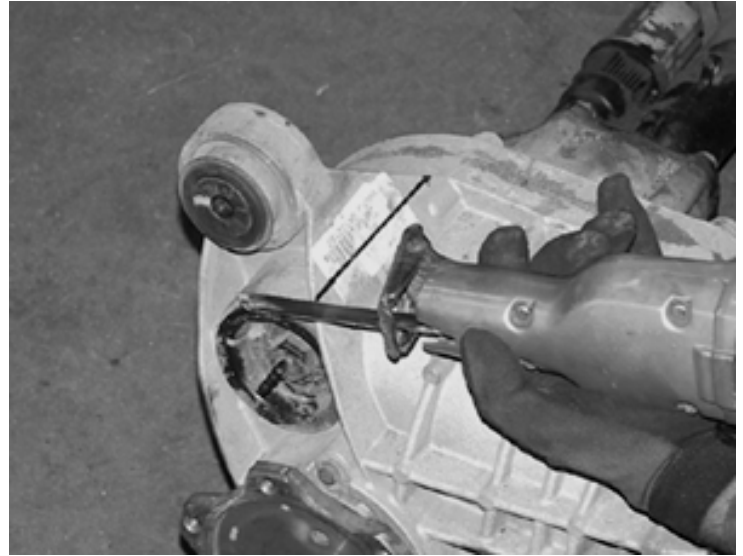

19. **On some model trucks**, the differential has a small area the needs to be sanded down level to allow the supplied Drv. Diff bracket to fit flush against the diff. Using a sanding disc, sand the differential as shown in the following two pictures. **USE CARE TO NOT SAND TOO FAR, YOU WILL ONLY NEED TO APPROX. 1/4"**. SEE PHOTO BELOW.



Before Sanding

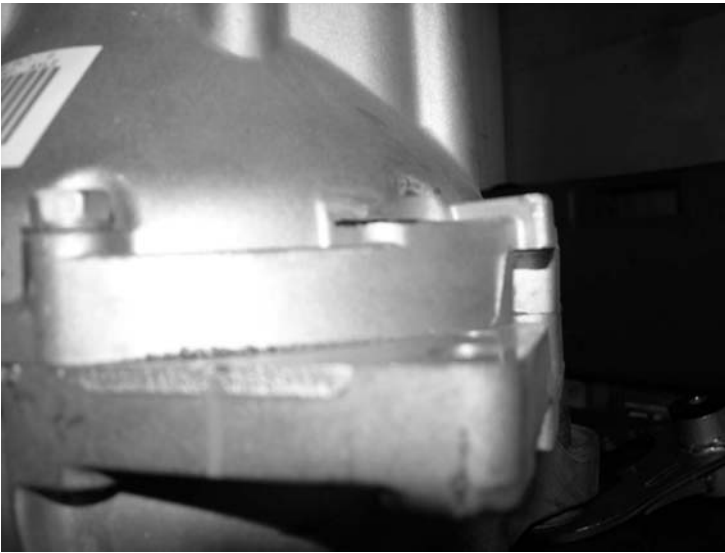

After Sanding

20. Locate the C shaped Fabtech differential bracket FT20062 and install bushings and sleeve in bracket from Bushing Kit FT90085.
21. Place differential bracket to the differential housing and remove the appropriate 5 housing bolts. Bracket should be positioned with the bushing eye to the top side of the housing. Using provided the 10mm x 1.5 x 60mm bolts and washers in hardware kit FT20465 attach the differential bracket to housing using thread lock compound and torque to 30 ft-lbs. Note - Some leakage of the differential oil is normal during this process. Recheck and fill diff housing oil once differential is mounted in vehicle. SEE PHOTO IN NEXT COLUMN



Diff Housing Bracket

22. Locate the Fabtech rear crossmember FT20458BK and install the factory cell foam bump stop in each end. SEE PHOTO BELOW

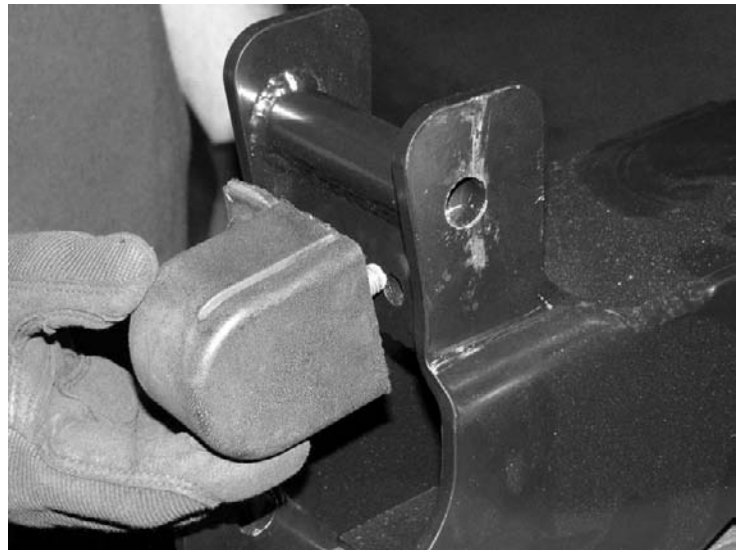

23. Install the Rear crossmember into the rear lower control arm pockets on the vehicle. SEE PHOTO BELOW.



24. Locate and install the Fabtech Passenger side Diff bracket FT20061 to the bottom of the factory frame mount, with the wide end of the bracket to front of the vehicle. Attach using the stock hardware. Torque to 70 ft-lbs. SEE PHOTO BELOW.

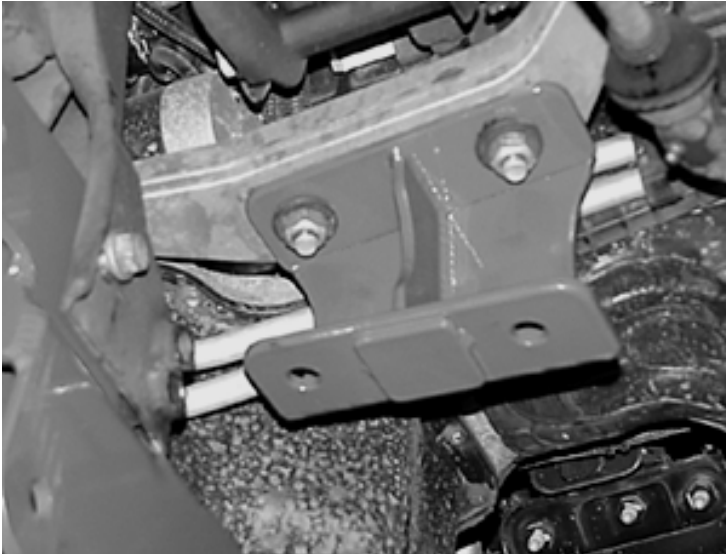

25. Place the differential housing into the Fabtech rear crossmember using the stock hardware on the driver side and 9/16"-12 x 1-3/4" bolts, nuts and washers on the passenger side from hardware kit FT20465, leave loose. SEE PHOTO BELOW



26. Position the front differential urethane bushing mount into the front crossmember tabs. Locate and install the differential skid plate around the differential housing bushing using 9/16"x 5" bolt, nut and washers from hardware kit FT20076. Leave loose.

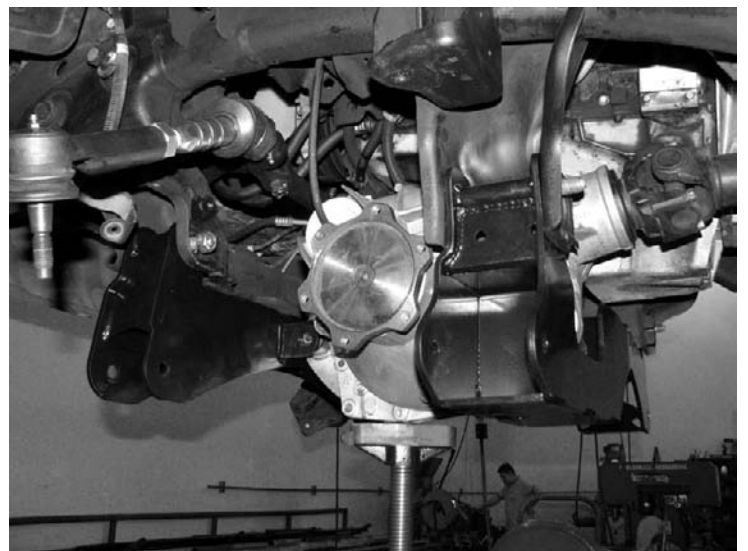

27. Reconnect the electrical connection and the vacuum line to the differential housing.
28. Install the lower control arms into the new crossmembers with the FT20284BK support tubes placed over the pivot bolts between the crossmembers. Use the 5/8" x 5" and 5/8" x 6-1/2" bolts, nuts and washers from hardware kit FT20465. Leave loose. SEE PHOTO BELOW.

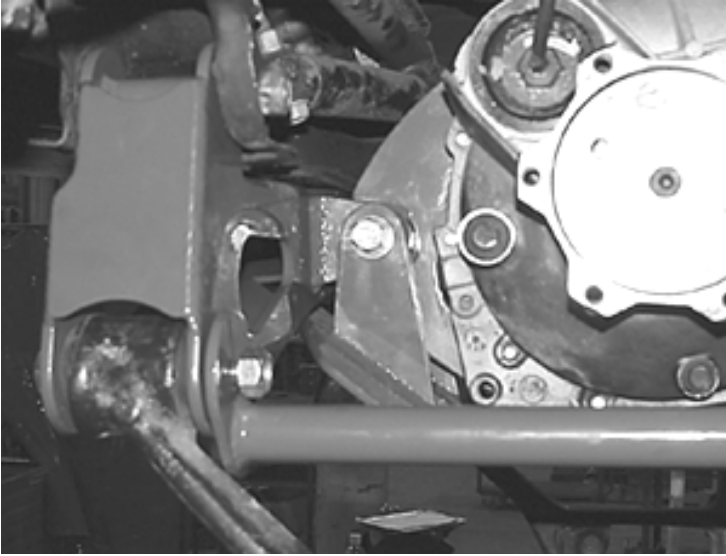

29. Using 1/2" x 1-1/4" Bolt, nut and washers attach the rear of the skid plate to the bottom of the rear crossmember and torque to 127 ft-lbs.
30. Torque the following bolts - Driver side diff bushing bolts to 184 ft-lbs, Passenger side diff bushing bolts to 184 ft-lbs, Crossmember frame pocket bolts to 184 ft-lbs, Control arm bolts to 184 ft-lbs. Recheck all bolts on the front end for proper torque before proceeding to next step.
31. Remove the factory shock mount on the lower control arm and discard. Save the Hardware.
32. Locate the FT20459 sleeve and install in to the torsion bar socket on the control arm. SEE PHOTO BELOW.



33. Locate the Torsion Bar Relocator FT20455BK and install it on to the lower control arm using the factory shock mount bolts and the supplied 3/4"-10 x 4-1/2" hardware. Torque the factory bolts to 58 ft-lbs and the 3/4 to 450 ft-lbs. SEE PHOTOS BELOW



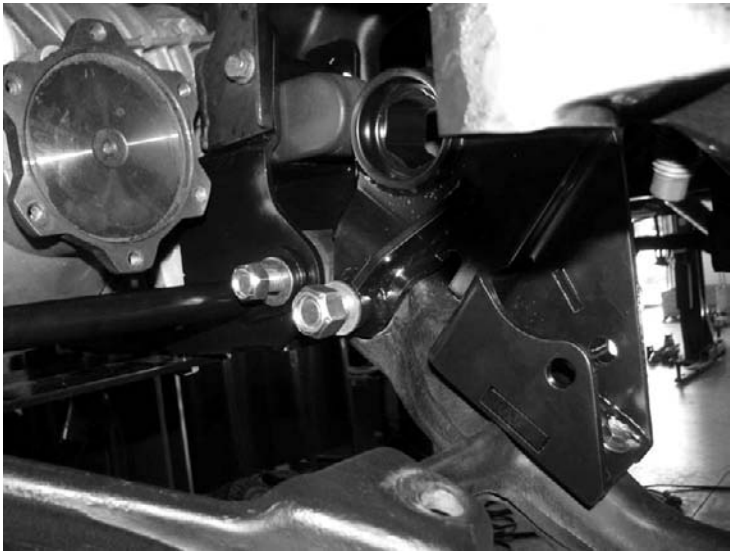

34. Locate the FT20246D & P steering knuckle and install the stock hub bearing assembly taking care to place O ring in the proper position. Apply thread lock compound to the stock hardware torque the flange bolts to 130 ft-lbs. SEE PHOTO BELOW.

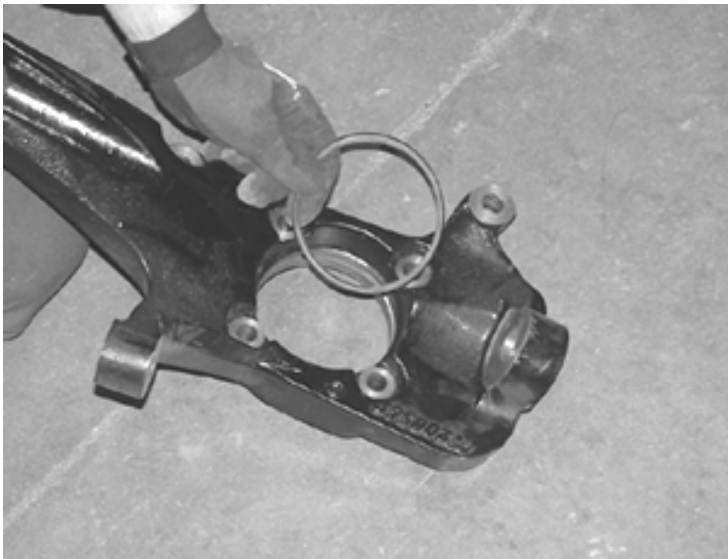

35. Attach the steering knuckle to the upper control arm and to the lower control arm using the stock hardware. Torque the upper ball joint to 35 ft-lbs and lower to 70 ft-lbs. Reattach the tie rod and torque to 30 ft-lbs.
36. Reinstall axle shaft through new knuckle and attach nut and washer. Locate and install the Fabtech CV spacers between the CV axle and the differential housing using 10mm x 40mm bolts and washers from Hardware kit FT20321 with the provided thread lock compound and torque to 55 ft-lbs in a cross pattern. Torque axle nut to 150 ft-lbs SEE PHOTO BELOW.

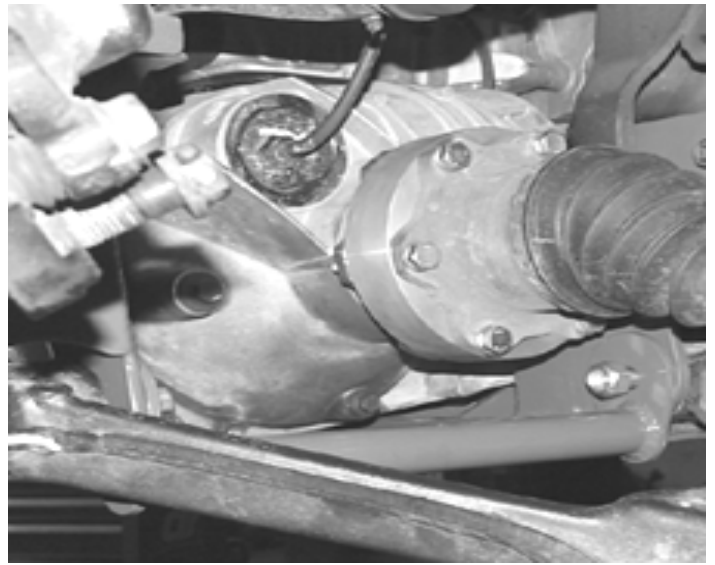

37. Locate the factory brake line mount on top of the upper control arm. Remove the brake line mount and route the line with bracket to the bottom side of the control arm. Drill a 13/64" hole directly below the original hole on the upper control arm. Mount the factory bracket to the bottom side of the control arm using the original mounting hardware. SEE PHOTO BELOW



38. Reinstall the torsion bars by pulling them through the torsion bar relocator bracket and then sliding it back into the factory torsion key. Set the torsion adjuster to the premeasured height. SEE PHOTO BELOW.

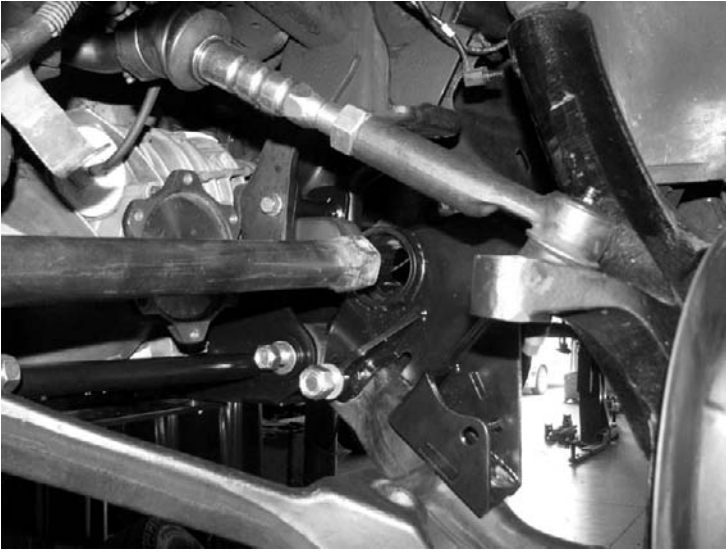

39. Install Fabtech shock part number FTS7191 (not included) using 9/16 - 12 x 4 - 1/2 hardware. Torque the upper stem bushing to 15 f-tlbs and the lower bolt to 129 ft-lbs.

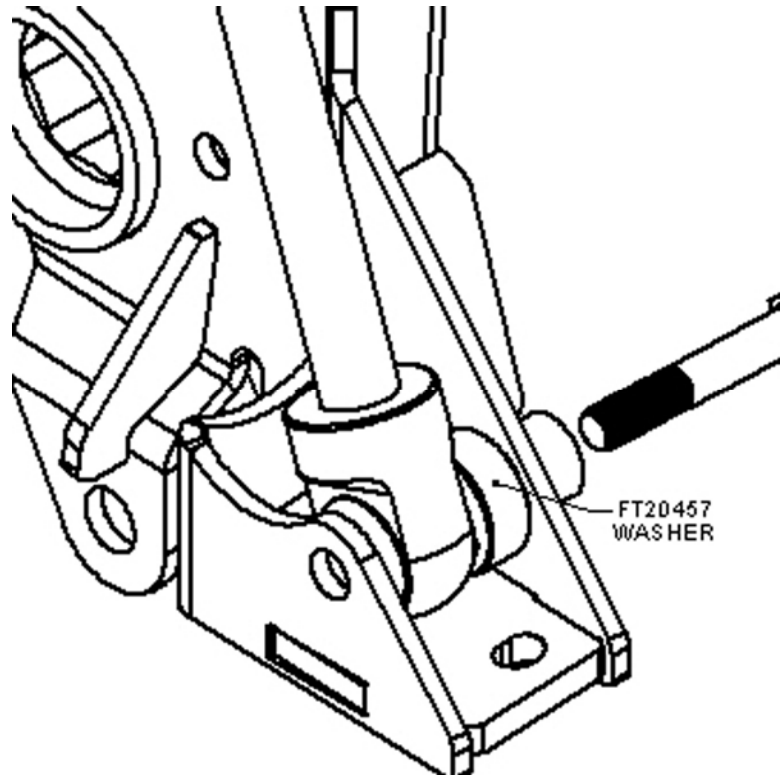

40. Reinstall brake rotor and caliper. **Note: If your brake caliper cage has the boss shown below, it must be ground / sanded flush with the cage before mounting the calipers. SEE PHOTOS.** Torque caliper bolts to 70 ft-lbs. Route the brake hose and ABS line to the steering knuckle using the factory steel guide clamp to the side of the steering knuckle and to the control arm bracket with 1/4" x 1" bolts, nuts and washers. Torque to 5 ft-lbs.

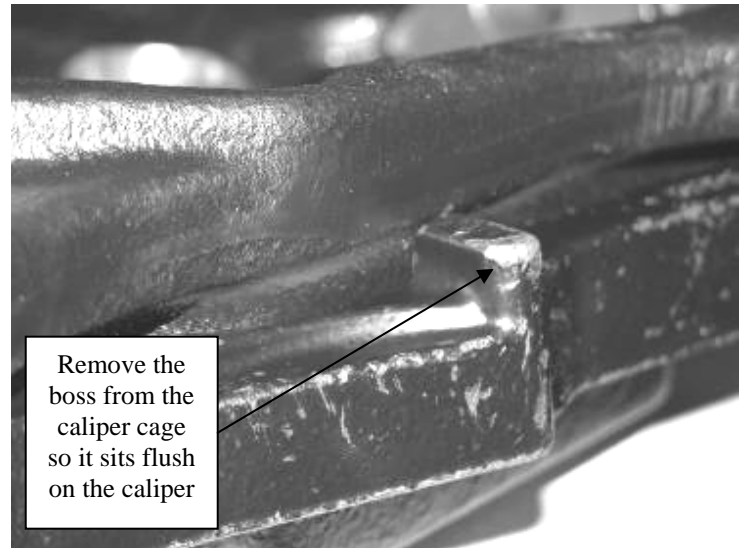

41. Reattach the drive shaft to the differential yoke using the stock hardware and torque u joint straps to 19 ft-lbs.
42. Remove sway bar and flip upside down and remount. Locate and install the Fabtech sway bar link ends and bushings. Torque to 10 ft-lbs. SEE PHOTO BELOW

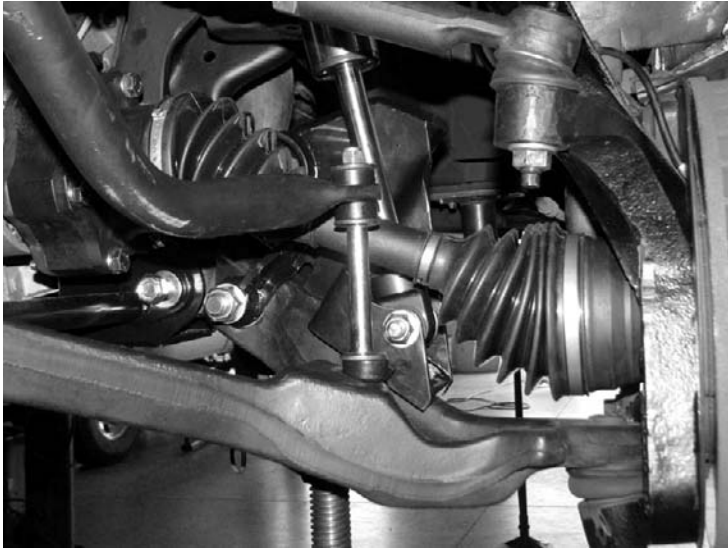

43. Recheck all bolts on front end for proper torque before proceeding to next step.

REAR SUSPENSION INSTRUCTIONS:

44. Jack up the rear end of the vehicle and support the frame rails with jack stands. Supporting the rear differential, remove and discard the rear shocks and u bolts. Lower axle down slowly. Use care not to over extend the brake hose.
45. Locate FT20140 rear brake hose extension bracket and install between differential housing and brake hose using 1/4" x 1-1/4" bolt, nut and washers and stock hardware. Torque to 10 ft-lbs. Check brake hose for proper extended length and routing as to allow full rear travel without over extending hose.
46. Disconnect the brake line distribution block at the axle and discard the factory bolt. Locate the FT70014 Brake Line Extension bracket, 1/4"-20 x 1 1/4" bolt, nylock nut and washers, 8mm x 25mm bolt and washer. Bolt the bracket to the axle using the 8mm hardware. Bolt the distribution block to the top of the bracket using the 1/4" hardware. Use care when routing / bending the hard brake line. SEE PHOTO BELOW

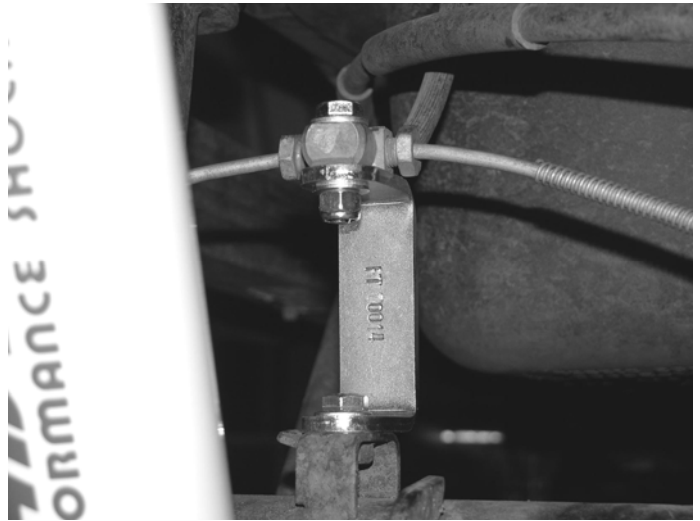

47. Locate and install the rear lift blocks with the provided short center pin on the bottom of the block to the axle. The integrated bump stop should face to the inside of the vehicle. Using the provided U bolts, nuts and washers align axle, lift blocks, and springs and torque to U Bolts to 90 ft-lbs. SEE PHOTO BELOW

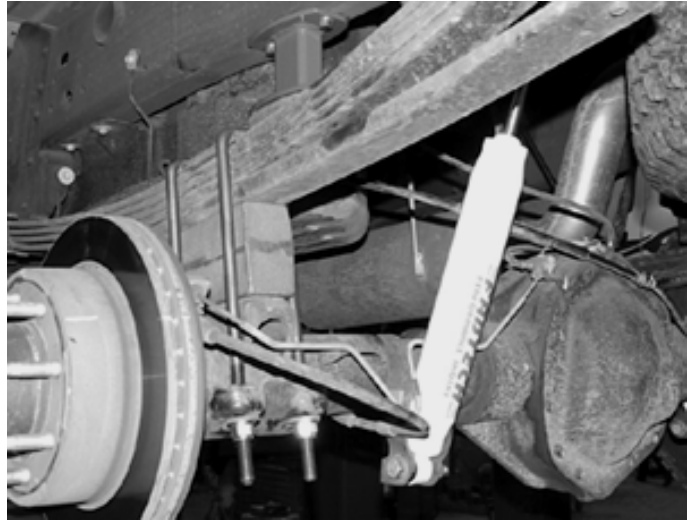

48. Install Fabtech shock part number FTS7333 (not included) with the factory hardware and torque bolts to 65 ft-lbs.
49. For vehicles with a two-piece rear driveshaft, locate and install FT20074 spacer between the carrier bearing and frame. Push out stock mounting bolts and use 3/8" x 2" bolts, nuts and washers. Torque to 30 ft-lbs SEE PHOTO BELOW



50. Recheck all bolts for proper torque. Recheck brake hoses and lines for proper clearances.
51. Check the fluid in the front differential and fill if needed with factory specification differential oil.
52. Install tires and wheels and torque lug nuts to wheel manufacturer's specifications. Turn front tires left to right and check for appropriate tire clearance. Note - Some oversized tires may require trimming of the front bumper & valance.
53. Check front end alignment and set to factory specifications. Readjust headlights.

INSTALLATION OF THIS SUSPENSION SYSTEM WILL NOT ALLOW THE USE OF THE FACTORY WHEELS OR SPARE TIRE ON THE FRONT SUSPENSION

RETORQUE ALL NUTS, BOLTS AND LUGS AFTER 50 MILES AND PERIODICALLY THEREAFTER.

For technical assistance call: 909-597-7800

Product Warranty and Warnings-

Fabtech provides a Limited Lifetime Warranty to the original retail purchaser who owns the vehicle, on which the product was originally installed, for defects in workmanship and materials.

The Limited Lifetime Warranty excludes the following Fabtech items; bushings, bump stops, ball joints, tie rod ends, limiting straps, cross shafts, heim joints. These parts are subject to wear and are not considered defective when worn. They are warranted for 60 days from the date of purchase for defects in workmanship.

Take apart shocks are considered a serviceable shock with a one year warranty on leakage only. Service seal kits are available separately for future maintenance. All other shocks are covered under our Limited Lifetime Warranty.

Fabtech does not warrant any product for finish, alterations, modifications and/or installation contrary to Fabtech's instructions. Alterations to the finish of the parts including but not limited to painting, powdercoating, plating and/or welding will void all warranties. Some finish damage may occur to parts during shipping which is considered normal and is not covered under warranty.

Fabtech products are not designed nor intended to be installed on vehicles used in race applications or for racing purposes or for similar activities. (A "RACE" is defined as any contest between two or more vehicles, or any contest of one or more vehicle against the clock, whether or not such contest is for a prize). This warranty does not include coverage for police or taxi vehicles, race vehicles, or vehicles used for government or commercial purposes. Also excluded from this warranty are sales outside of the United States of America.

Installation of most suspension products will raise the center of gravity of the vehicle and will cause the vehicle to handle differently than stock. It may increase the vehicle's susceptibility to a rollover, on road and off road, at all speeds. Extreme care should be taken to operate the vehicle safely at all times to prevent rollover or loss of control resulting in serious injury or death. Fabtech front end Desert Guards may impair the deployment or operation of vehicles equipped with supplemental restraining systems/air bag systems and should not be installed if the vehicle is equipped as so.

Fabtech makes every effort to ensure suspension product compatibility with all vehicles listed in the catalog, but due to unknown auto manufacturers production changes and/or inconsistencies by the auto manufacturer, Fabtech cannot be responsible for 100% compatibility, including the fitment of tire and wheel sizes listed. The Tire and Wheel sizes listed in Fabtech's catalog are only a guideline for street driving with noted fender trimming. Fabtech is not responsible for damages to the vehicle's body or tires.

Fabtech's obligation under this warranty is limited to the repair or replacement, at Fabtech option, of the defective product only. All costs of removal, installation or re-installation, freight charges, incidental or consequential damages are expressly excluded from this warranty. Fabtech is not responsible for damages and/or warranty of other vehicle parts related or non related to the installed Fabtech product. This warranty is expressly in lieu of all other warranties expressed or implied. This warranty shall not apply to any product that has been subject to accident, negligence, alteration, abuse or misuse as determined by Fabtech.

Fabtech suspension components must be installed as a complete system including shocks as shown in our current catalog. All warranties will become void if Fabtech parts are combined and/or substituted with other aftermarket suspension products. Combination and/or substitution of other aftermarket

suspension parts may cause premature wear and/or product failure resulting in an accident causing injury or death. Fabtech does not warrant products not manufactured by Fabtech.

Installation of Fabtech product may void the vehicles factory warranty; it is the consumer's responsibility to check with their local vehicle's dealer for warranty disposition before the installation of the product.

It is the responsibility of the distributor and/or the retailer to review all warranties and warnings of Fabtech products with the consumer prior to purchase.

Fabtech reserves the right to supercede, discontinue, change the design, finish, part number and, or application of parts when deemed necessary without written notice. Fabtech is not responsible for misprints or typographical errors within the catalog or price sheet.

Instruction Sheet Part #- FT21089i

9/20/11 JP